

ITD1141

# ***AXLE SLIDE MOUNT*** ***TUNNEL VERSION*** **MANUAL**

EDITION-2 VOLUME-2

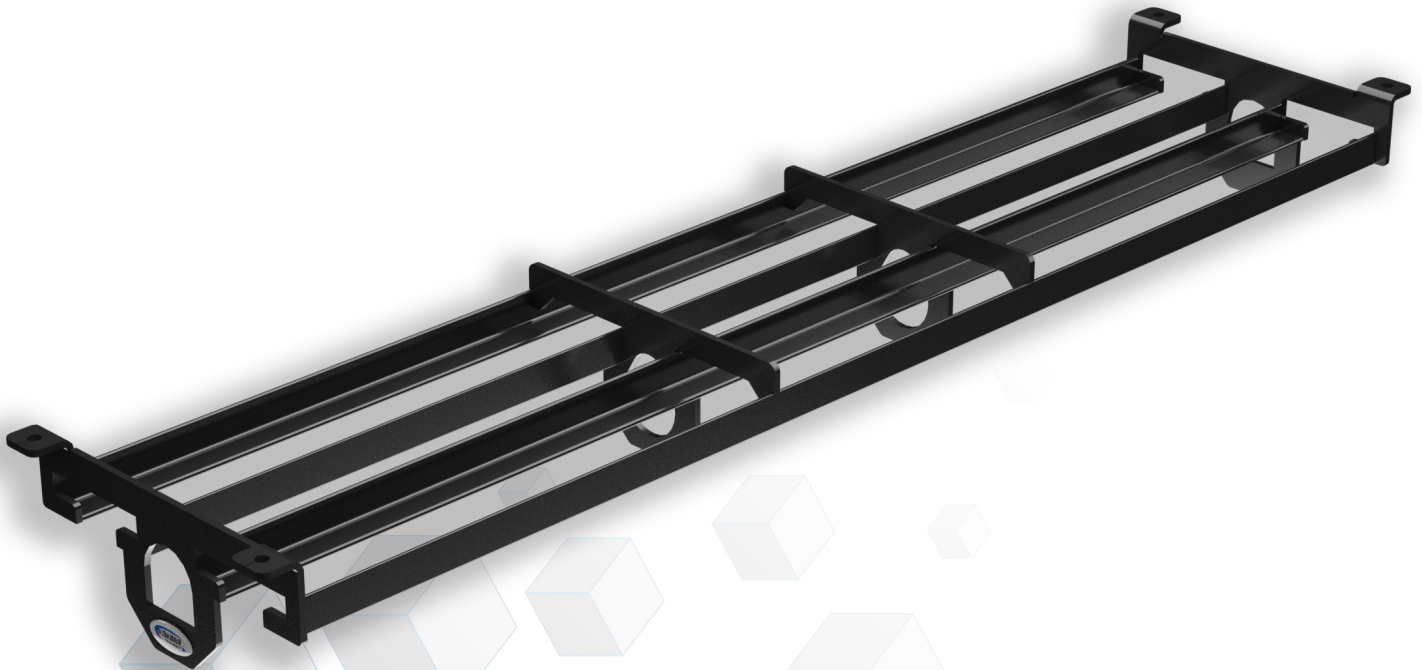

VISIT OUR WEBSITE!  
**IN THE DITCH.COM**



PHONE: 1-208-587-7960  
EMAIL: [sales@intheditch.com](mailto:sales@intheditch.com)

# MANUAL INFORMATION

## INTRODUCTION

---

Everyone here at In The Ditch™ would like to thank you for your recent purchase of one of our products, and tell you congratulations! Our passion is to provide our customers with the best products and parts money can buy, as well as serve the towing industry and our local community here in Mountain Home, Idaho! Without support from valued customers such as yourselves, our business, as well as the people who work for it, wouldn't survive. We hope you find our products useful, and get the most out of every experience with them. Thank you!



### **ATTENTION**

This manual should be read carefully. It contains important information that needs to be fully understood and followed in order to ensure that the In The Ditch Products discussed in this manual are used properly so as to ensure the safety of all persons (e.g. operators, customers, bystanders).

# CONTENTS

- WARRANTY INFORMATION——4
- ITD1141 AXLE SLIDE MOUNT TUNNEL VERSION——6
  - INSTALLATION GUIDELINES——6

# WARRANTY INFORMATION

ITD0688R3

## Limited Warranty

In The Ditch Towing Products (also referred to herein as ITD) warrants to the original purchaser that new ITD manufactured goods will be free from defects in material and workmanship for a period of twelve (12) months from the date placed in service. The purchaser must promptly notify ITD in writing of any failure in material or workmanship. In no event shall ITD accept such notification later than twelve (12) months from the date placed in service.

ITD's obligation under this warranty, statutory or otherwise, is limited to the repair or replacement at the ITD factory, or at a point designated by ITD, of such part or parts as shall appear upon inspection by ITD to be defective in material or workmanship. This warranty is not transferable. This warranty does not obligate ITD to bear the cost of labor or transportation charges in connection with the repair or replacement of any part(s) found to be defective, nor shall it apply to a product upon which repairs or alterations have been made unless such repairs or alterations were authorized by ITD.

Except as expressly set forth in this warranty, ITD makes no other warranty, express or implied, and hereby disclaims all other warranties including, but not limited to, the implied warranties of merchantability and fitness for a particular purpose. ITD shall in no event be liable for any claims for downtime, loss of profits or goodwill, or any claims for other special, incidental, indirect, or consequential damages concerning or relating to any product or parts, whether based on negligence, strict liability, breach of contract, breach of warranty, misrepresentation, or any other legal theory, regardless of whether the loss resulted from any general or particular requirement which ITD knew or had reason to know about at the time of sale.

ITD makes no warranty, express or implied, as to the finished products manufactured or supplied by another manufacturer and supplied by ITD to purchaser, including, but not limited to, any vehicle to which an ITD product may be affixed or any accessories, and ITD expressly disclaims any implied warranties of merchantability and fitness for a particular purpose as to such equipment or products. This language shall in no way affect or diminish the rights of the purchaser to rely on such warranties as are extended by such manufacturers or suppliers. ITD shall, to the extent permitted under applicable law, pass on to the purchaser such manufacturer's or seller's warranty.

The customer must obtain and present a written authorization number from ITD prior to any work beginning, and the customer agrees to bear all costs. Please note: Merchandise covered by a manufacturer's warranty must be sent directly to the manufacturer for replacement or repair. ITD, whose policy is one of continuous improvement, reserves the right to improve its products through changes in design or materials as it may deem desirable without being obligated to incorporate such changes in any products previously sold.

This warranty is not intended to cover and shall not apply or include the following items, which are set forth by way of example only: normal deterioration of trim, paint, lettering, appearance of items due to wear or exposure to weather, road conditions, road treatments, etc.; any damage or defect due to accident, misuse, abuse, operation exceeding rated loads, improper or unauthorized repairs, failure to provide reasonable and necessary maintenance, or uses in respect of which the equipment was not designed or intended; alterations or modifications that affect performance, operations, or reliability.

It is expressly understood that ITD makes no implied or express warranty that ITD manufactured goods shall be fit for the purpose of lifting or moving people or for any other improper use. Field modification of this unit without the advice and written consent of the ITD Engineering Department will void all warranties and any guarantees pertaining to both purchased components used in the manufacture of this unit, as well as structurally fabricated parts supplied by ITD. Use of other than factory or factory authorized parts will render the warranty void.

## Notice to Owner or User

It is very important that you properly fill out your product registration form at [registration.intheditch.com](http://registration.intheditch.com) to register your equipment. By submitting the information within 15 days of your purchase, your warranty will be validated, ensuring that your equipment will be protected subject to the terms and conditions set out herein. In the event we need to contact you concerning your registered equipment, Product Updates, Service Bulletins, or Product Recalls, the information you have provided on the product registration form will ensure your immediate notification. Do your part and let us help you by filling out your product registration form.

## Installation Guidelines

Due to variances in manufacturers' wrecker bodies, truck bodies and mounting surfaces, ITD cannot provide explicit mounting requirements for every mounting option. These instructions are to serve only as a guideline. Final installation requirements are left to the discretion of a qualified installer.

## Assumption of Risk

Towing and recovery (collectively "Towing") is by nature an inherently dangerous activity. As a consequence, towing operators assume the risk of serious injury or death. ITD products are only intended to be used solely by towing operators who have the requisite training and experience who not only understand the proper use of the product/s but also fully understand all risks associated with towing.

If you do not have the requisite experience and training as a towing operator DO NOT USE these products.

# WARRANTY INFORMATION

ITD0688R3

## Inspection

- ITD requires that each operator of a truck or transport vehicle perform a detailed circle check before and after each use of the truck or transport vehicle. This inspection must include the power unit, the towing unit, and all items installed on the unit.
- Do not take chances with your life or other people's lives. Make sure all items are secured and in safe working order.
- Always inspect products for any signs of paint cracking, metal fatigue or premature wear.
- Maintain a visual inspection along with grabbing the products and wiggling or pulling on it to make sure there is no way anything can become dislodged from its mount.
- Remove from service immediately if repairs are needed. Do not take chances.

## Paint, Powder Coated and Polished Finishes:

The ITD warranty does not cover coatings or finishes, of powder coated products, galvanized products, zinc plated products, bare aluminum products, polished or non-polished stainless steel products or finishes. This includes, but is not limited to, scratches, peeling, chipping, hazing, dulling of finish or surface.

## Modifications to ITD Products

- DO NOT modify or tamper with any ITD Product. Doing so will void any applicable warranty and may result in serious injury or death.
- Warranties will be voided if any ITD Product is modified or tampered with.

## Securement

- The driver/operator must verify that all hardware is secure and tight. This includes, but is not limited to, mounting hardware and retaining systems.
- It is the driver /operator's responsibility to ensure that nothing can come loose from any part of the truck or transport vehicle or the vehicle being towed. It is the operator's responsibility to make sure that all items are in good working order and are properly secured.
- Only a qualified installer should mount ITD equipment. It is the installer's responsibility to ensure mounts are secure.
- It is the operator's responsibility to ensure his or her load is secured properly to the mounts.
- ITD recommends taking this approach to load/product securement:
  1. Imagine if you took your truck and turned it upside down. Nothing should fall out of or off of the truck.
  2. Now imagine if you stood the truck on the end where the front bumper was facing straight up into the sky. Nothing should fall out of or off the truck.
  3. Now imagine the rear bumper was facing the sky. Nothing should fall out of or off of the truck.

## Mix and Matching of different Manufacturer's Products

- Only use In The Ditch brand mounts with In The Ditch Products.
- Only use In The Ditch brand replacement parts for In The Ditch brand products.
- Failure to do so may result in voiding any applicable warranty and serious bodily injury or death.



# ITD1141 AXLE SLIDE MOUNT TUNNEL VERSION

## INSTALLATION GUIDELINES

### RECOMMENDED HARDWARE: (NOT INCLUDED)

- (4) 5/16" Bolts (Grade 5 or Better)
- (4) 5/16" Nuts (Grade 5 or Better)
- (4) 5/16" Fender Washers
- (4) 5/16" Washers

**SECUREMENT** *It is the driver / operator's responsibility to ensure that nothing can come loose from any part of the truck or transport vehicle, or the vehicle being towed. It is the operator's responsibility to make sure that all items are in good working order and are properly secured!*

**!** *Due to variances in manufacturers' wrecker bodies, truck bodies and mounting surfaces, ITD cannot provide explicit mounting requirements for every mounting option. These instructions are to serve only as a guideline. Final installation requirements are left to the discretion of a qualified installer.*

**!** *Always mount to a flat, level surface. Do not mount at an angle!*

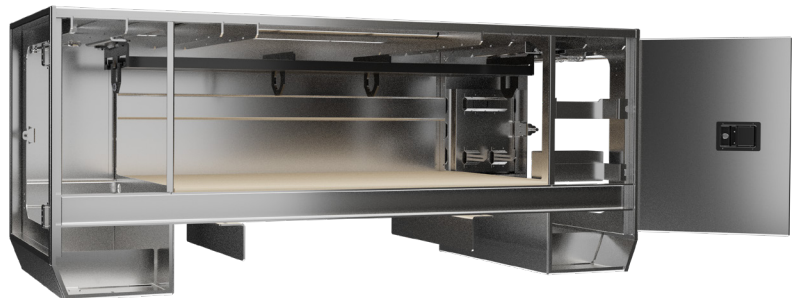

**!** *Failure to follow the safety guidelines listed may result in voiding any applicable warranty, serious bodily injury, or death.*

**!** It is very important that you properly fill out your product registration form at [registration.intheditch.com](http://registration.intheditch.com) to register your equipment. By submitting the information within 15 days of your purchase, your warranty will be validated, ensuring that your equipment will be protected subject to the terms and conditions set out herein. In the event we need to contact you concerning your registered equipment, Product Updates, Service Bulletins, or Product Recalls, the information you have provided on the product registration form will ensure your immediate notification. Do your part and let us help you by filling out your product registration form.

⚠️ *Due to variances in manufacturers' wrecker bodies, truck bodies and mounting surfaces, ITD cannot provide explicit mounting requirements for every mounting option. These instructions are to serve only as a guideline. Final installation requirements are left to the discretion of a qualified installer.*

⚠️ *Always mount to a flat, level surface. Do not mount at an angle!*

- 1 Place Axle Slide mount in desired location. Verify axles and bar will slide easily without obstruction (**Fig.1 & Fig.2**).

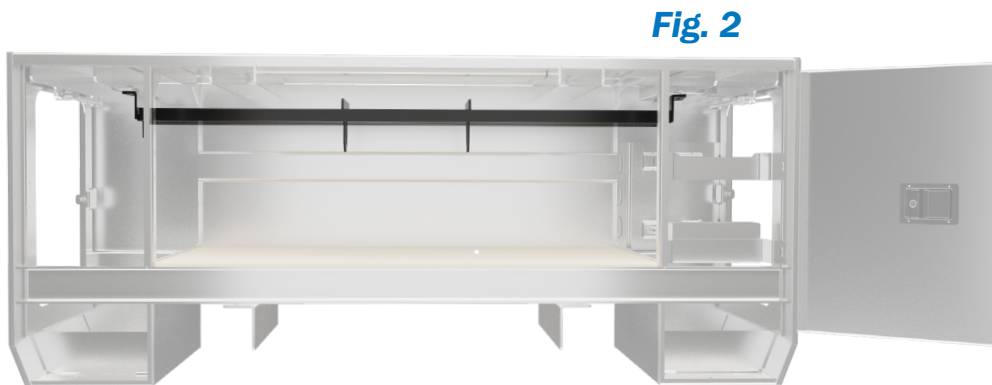
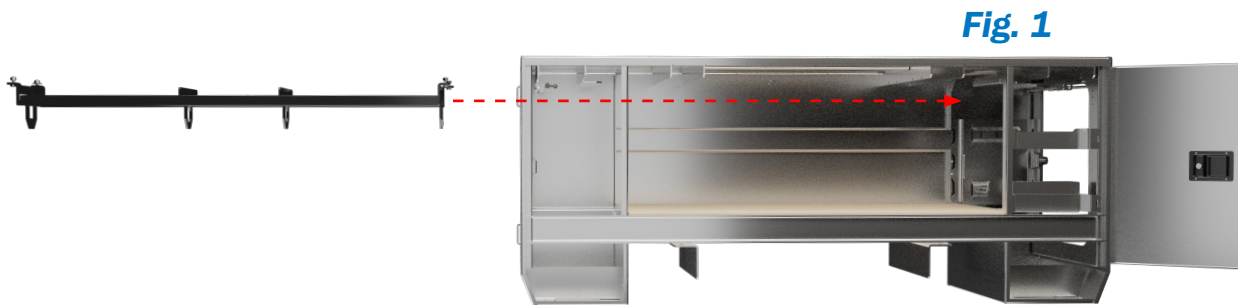

⚠️ *Most applications will need additional mounts to lower the product below the lip of the door.*

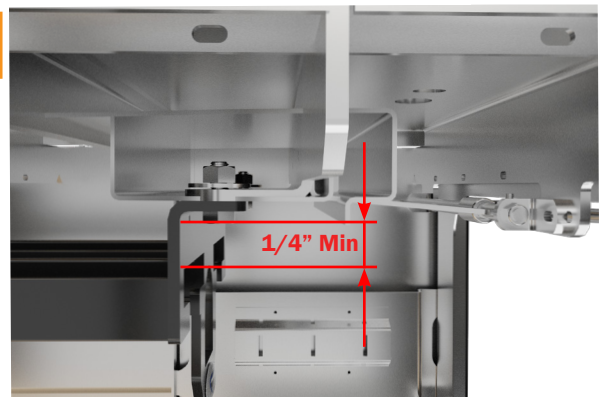

⚠️ **Failure to follow the safety guidelines listed may result in voiding any applicable warranty, serious bodily injury, or death.**

⚠️ It is very important that you properly fill out your product registration form at [registration.intheditch.com](http://registration.intheditch.com) to register your equipment. By submitting the information within 15 days of your purchase, your warranty will be validated, ensuring that your equipment will be protected subject to the terms and conditions set out herein. In the event we need to contact you concerning your registered equipment, Product Updates, Service Bulletins, or Product Recalls, the information you have provided on the product registration form will ensure your immediate notification. Do your part and let us help you by filling out your product registration form.



**Fig. 4**

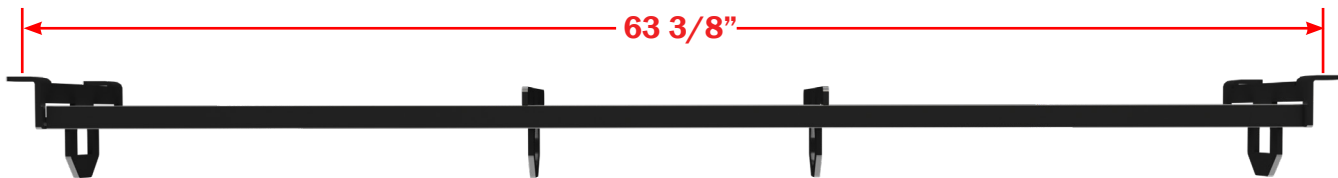

**MIXING & MATCHING PRODUCTS**

- Only use In The Ditch brand mounts with your In The Ditch Products.
- Only use In The Ditch brand replacement parts for your In The Ditch brand products.

**ALWAYS FOLLOW STATE & LOCAL GUIDELINES!**

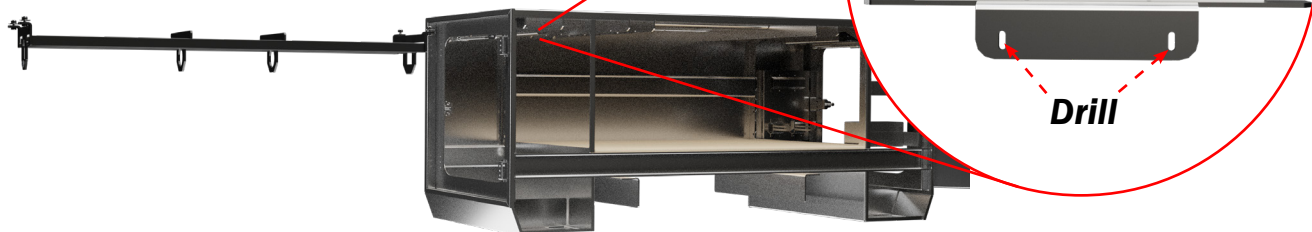

**Fig. 5**

**2** With your mount aligned, mark 4 hole positions on your toolbox and drill (Fig. 6).

**Before drilling holes, verify there are no electrical wires in the way.**

**Fig. 6**



**3** Utilize 4 - 5/16" bolts with fender washers to help distribute load. (Fig. 7)

**Fender Washer**

**Fig. 7**

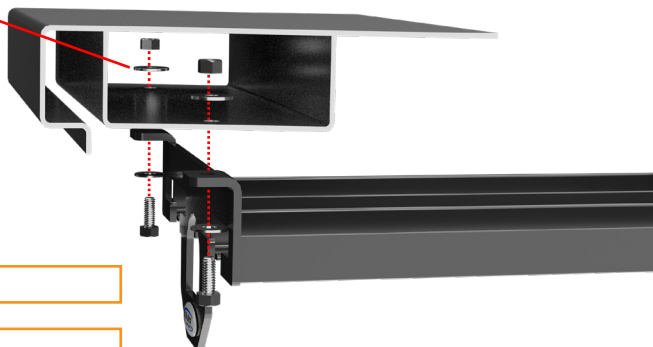

**Before First Use Checklist: All nuts and bolts are tight.**

**Inspect and retighten after first 10 uses**

**Failure to follow the safety guidelines listed may result in voiding any applicable warranty, serious bodily injury, or death.**

It is very important that you properly fill out your product registration form at [registration.intheditch.com](http://registration.intheditch.com) to register your equipment. By submitting the information within 15 days of your purchase, your warranty will be validated, ensuring that your equipment will be protected subject to the terms and conditions set out herein. In the event we need to contact you concerning your registered equipment, Product Updates, Service Bulletins, or Product Recalls, the information you have provided on the product registration form will ensure your immediate notification. Do your part and let us help you by filling out your product registration form.





 Due to variances in manufacturers' wrecker bodies, truck bodies and mounting surfaces, ITD cannot provide explicit mounting requirements for every mounting option. These instructions are to serve only as a guideline. Final installation requirements are left to the discretion of a qualified installer.

 Always mount to a flat, level surface. Do not mount at an angle!

 ITD Brand Dollies, Axles, Mounts, and related products are intended to be used solely by towing operators who have the requisite training and experience. If you do not have the requisite experience and training as a towing operator DO NOT USE these products.

 **SECUREMENT** It is the driver / operator's responsibility to ensure that nothing can come loose from any part of the truck or transport vehicle, or the vehicle being towed. It is the operator's responsibility to make sure that all items are in good working order and are properly secured!

 **MODIFICATION** DO NOT modify or tamper with any ITD product. Doing so will void any applicable warranty and may result in serious injury or death. • Warranties will be voided if any ITD Product is modified or tampered with!

 **INSPECTION** ITD requires that each operator of a truck or transport vehicle perform a detailed circle check before and after each use of the truck or transport vehicle. This inspection must include the power unit, the towing unit, and all items installed on the unit.

- Do not take chances with your life or other people's lives. Make sure all items are secured and in safe working order.
- Always inspect products for any signs of paint cracking, metal fatigue or premature wear.
- Maintain a visual inspection along with grabbing the products and wiggling or pulling on it to make sure there is no way anything can become dislodged from it's mount.
- Remove from service immediately if repairs are needed. Do not take chances.

 **MIXING & MATCHING PRODUCTS**

- Only use In The Ditch brand mounts with your In The Ditch Products.
- Only use In The Ditch brand replacement parts for your In The Ditch brand products.

 • ALWAYS FOLLOW STATE & LOCAL GUIDELINES!

 Failure to follow the safety guidelines listed may result in voiding any applicable warranty, serious bodily injury, or death.

 It is very important that you properly fill out your product registration form at [registration.intheditch.com](http://registration.intheditch.com) to register your equipment. By submitting the information within 15 days of your purchase, your warranty will be validated, ensuring that your equipment will be protected subject to the terms and conditions set out herein. In the event we need to contact you concerning your registered equipment, Product Updates, Service Bulletins, or Product Recalls, the information you have provided on the product registration form will ensure your immediate notification. Do your part and let us help you by filling out your product registration form.

**PAGE INTENTIONALLY LEFT BLANK**

**PAGE INTENTIONALLY LEFT BLANK**

# Go to [REGISTRATION.INTHEDITCH.COM](http://REGISTRATION.INTHEDITCH.COM) for product registration

## ITS AS EASY AS THESE 4 STEPS!

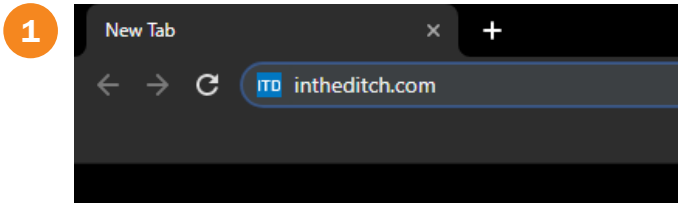

In your browser, navigate to [intheditch.com](http://intheditch.com)

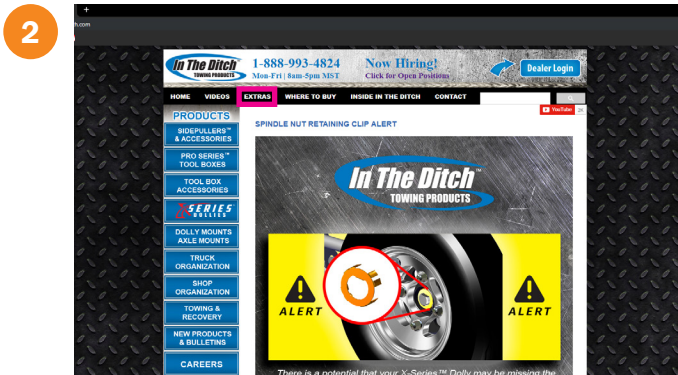

After navigating to [intheditch.com](http://intheditch.com), hover over the extras tab to view an expanded list of links.

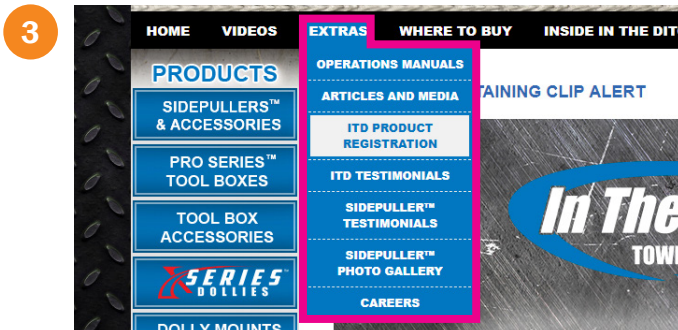

Under the Extras tab, click on "ITD Product Registration".

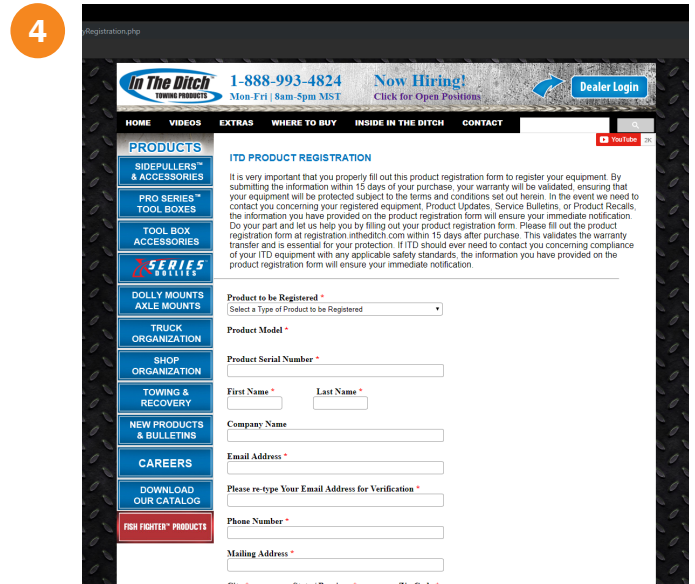

Complete the form located on the product registration page.

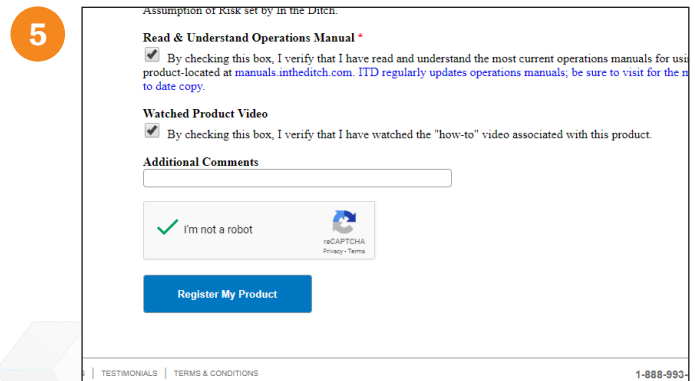

After completing the form, make sure you complete the captcha at the bottom, and click on the "Register My Product" button.

It is very important that you properly fill out your product registration form at [registration.intheditch.com](http://registration.intheditch.com) (follow the screenshots above) to register your equipment. By submitting the information within 15 days of your purchase, your warranty will be validated, ensuring that your equipment will be protected subject to the terms and conditions set out herein. In the event we need to contact you concerning your registered equipment, Product Updates, Service Bulletins, or Product Recalls, the information you have provided on the product registration form will ensure your immediate notification. Do your part and let us help you by filling out your product registration form. Please fill out the product registration form at [registration.intheditch.com](http://registration.intheditch.com) within 15 days after purchase. This validates the warranty transfer and is essential for your protection. If ITD should ever need to contact you concerning compliance of your ITD equipment with any applicable safety standards, the information you have provided on the product registration form will ensure your immediate notification.

In the event you were not the original purchaser of the product, we still need you to register your In The Ditch Products.

**PLEASE TAKE THE TIME TO FILL OUT THE PRODUCT WARRANTY FORM.**

**GO TO: [REGISTRATION.INTHEDITCH.COM](http://REGISTRATION.INTHEDITCH.COM)**

**IF YOU HAVE ANY QUESTIONS PLEASE CALL IN THE DITCH: 1-208-587-7960**

**VISIT OUR WEBSITE!  
IN THE DITCH.COM**



**PHONE: 1-208-587-7960  
EMAIL: [sales@intheditch.com](mailto:sales@intheditch.com)**